

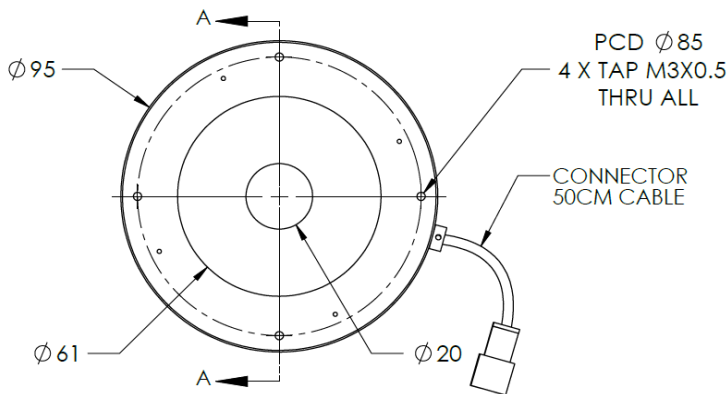

ILLUMINATOR DATA-ID

IDS5-00-070-1-R-24V

Lighting Dimension

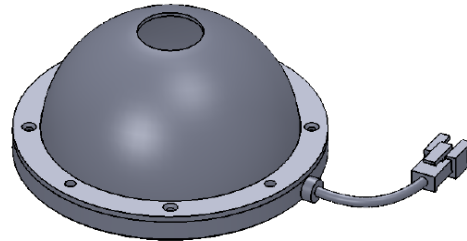
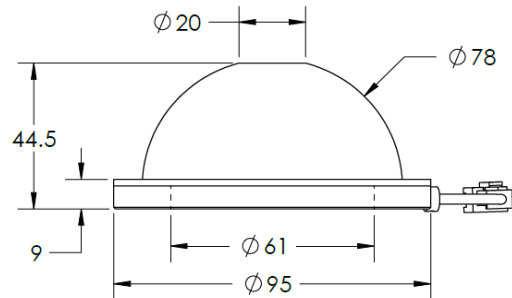

SECTION A-A
SCALE 1 : 1.5

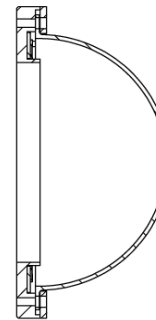

Mechanical Information	
Casing Material	Aluminium
Storage Temperature Range	Temp 0-45°C, Humidity 20-85%
Weight	115 g
Length / Outer Diameter	95 mm
Width / Inner Diameter	20 mm
Thickness / Height	44.5 mm



ILLUMINATOR DATA-ID

IDS5-00-070-1-R-24V

Optical Information		IDS5-00-070-1-R-24V		
Part Number		IDS5-00-070-1-R-24V		
LED Color		RED		
Wavelength	(nm)	620		
Intensity (±15%)	(Lux)	15980	10910	4430
Working Distance	(mm)	20	30	60
Illumination (number of row)		1		
Illumination Active Area				
Active Length / Outer Diameter	(mm)	61		
Active Width / Inner Diameter	(mm)	20		
Emission angle	(deg.)	0		
Eye Safety Class (IEC62471)		EXEMPT		
Electrical Information				
Lighting Supply Voltage (constant voltage mode)		24V ± 2%		
Continuous Current	(mA)	378		
Power Consumption	(W)	9.072		
Lighting casing temperature, Operating after 60 minutes	°C	54		
Strobe Mode Specification				
Pulse Operation		YES		
Max. Lighting Supply Voltage (Constant voltage power supply)	(V)	Pulsing at 24VDC to 48VDC, 0-10% Duty Cycle, Recommended at 36VDC		
Pulse Current, (Max. 10msec) (Constant current power supply)	(mA)	1134		
Max. Trigger Pulse Duration	(msec)	10		
Duty Cycle		0-10%		
Additional Information				
Additional Cooling Method		Attached to machine part for better heat dissipation		
Intensity Controller Selection		ANG, ST, SD and SDA Series		
CE Conformity		YES		
RoHS Compliance		YES		
Connection				
Connector Type (Default):		JST SMR-03V		
Cable Length out from lighting :	(mm)	500		
Pin Configuration :		Pin	Signal	Cable Color
		1	LED +	RED
		2	N.C.	---
		3	LED -	WHITE
				
Application				
Illumination Type		Indirect Illumination		
Applicattion Use		Crack, chip, stains on circular or cylindrical objects, solder inspection and substract inspection.		



ILLUMINATOR DATA-ID

IDS5-00-070-1-R-24V

Uniform Graph (Relative Irradiation Strength) - Representative pattern

Lens focal length, $f = 0.2$
CWD = 103mm
LWD = 30mm, 40mm, 50mm
Lighting angle: 0°

Tolerance	L X W
10%	16 X 21
20%	34 X 32
30%	41 X 32
40%	42 X 32

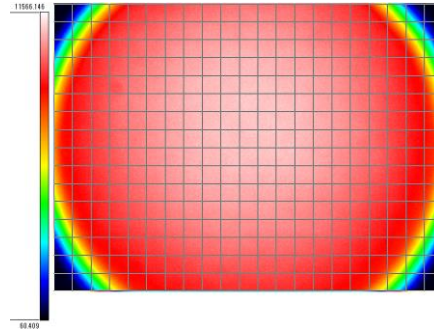
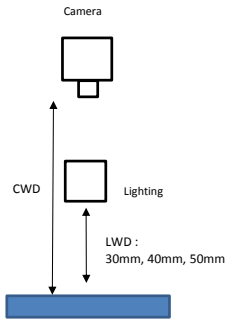

* 1 cell = 2mm x 2mm